

### Features

- 650V Field Stop Trench IGBT Technology
- Low Switching Loss for a Wide Temperature Range
- Positive Temperature Coefficient
- Easy Parallel Operation
- RoHS Compliant
- JEDEC Qualification
- 175°C Operating Temperature

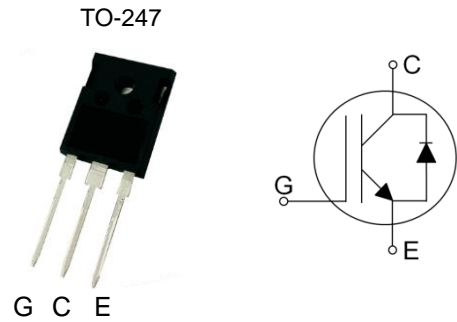

### Applications

UPS, Inverter, Solar, Welder

Device	Package	Marking	Remark
TGH80N65F2DS	TO-247	TGH80N65F2DS	RoHS

### Absolute Maximum Ratings

Parameter	Symbol	Value	Unit
Collector-Emitter Voltage	$V_{CES}$	650	V
Gate-Emitter Voltage	$V_{GES}$	$\pm 20$	V
Continuous Collector Current	$I_C$	$T_C = 25\text{ }^\circ\text{C}$	160
		$T_C = 100\text{ }^\circ\text{C}$	80
Pulsed Collector Current (Note 1)	$I_{CM}$	240	A
Diode Continuous Forward Current	$I_F$	80	A
Diode Pulsed Forward Current (Note 1)	$I_{FM}$	300	A
Power Dissipation	$P_D$	$T_C = 25\text{ }^\circ\text{C}$	577
		$T_C = 100\text{ }^\circ\text{C}$	288
Operating Junction Temperature	$T_{vj}$	-55 ~ 175	$^\circ\text{C}$
Storage Temperature Range	$T_{STG}$	-55 ~ 150	$^\circ\text{C}$
Maximum lead temperature for soldering purposes, 1/8" from case for 5 seconds	$T_L$	300	$^\circ\text{C}$

Notes :

(1) Repetitive rating : Pulse width limited by maximum junction temperature.

### Thermal Characteristics

Parameter	Symbol	Value	Unit
Maximum Thermal resistance, Junction-to-Case	$R_{\theta JC}$ (IGBT)	0.26	$^\circ\text{C/W}$
Maximum Thermal resistance, Junction-to-Case	$R_{\theta JC}$ (DIODE)	1.0	$^\circ\text{C/W}$
Maximum Thermal resistance, Junction-to-Ambient	$R_{\theta JA}$	40	$^\circ\text{C/W}$

### Electrical Characteristics of the IGBT $T_{vj}=25^{\circ}\text{C}$ , unless otherwise noted

Parameter	Symbol	Test condition	Min.	Typ.	Max.	Unit
<b>OFF</b>						
Collector – Emitter Breakdown Voltage	$BV_{CES}$	$V_{GE} = 0V, I_C = 1mA$	650	--	--	V
Zero Gate Voltage Collector Current	$I_{CES}$	$V_{CE} = 650V, V_{GE} = 0V$	--	--	1	mA
Gate – Emitter Leakage Current	$I_{GES}$	$V_{CE} = 0V, V_{GE} = \pm 20V$	--	--	$\pm 250$	nA
Integrated Gate Resistance	$R_{G(int)}$	$f = 1MHz, \text{Open Collector}$	--	2.3	--	$\Omega$
<b>ON</b>						
Gate – Emitter Threshold Voltage	$V_{GE(TH)}$	$V_{GE} = V_{CE}, I_C = 80mA$	4.0	6.0	7.5	V
Collector – Emitter Saturation Voltage	$V_{CE(SAT)}$	$V_{GE} = 15V, I_C = 80A, T_{vj} = 25^{\circ}\text{C}$	--	1.85	2.25	V
		$V_{GE} = 15V, I_C = 80A, T_{vj} = 125^{\circ}\text{C}$	--	2.19	--	V
		$V_{GE} = 15V, I_C = 80A, T_{vj} = 175^{\circ}\text{C}$	--	2.40	--	V
<b>DYNAMIC</b>						
Input Capacitance	$C_{IES}$	$V_{CE} = 30V$ $V_{GE} = 0V$ $f = 1MHz$	--	5000	--	pF
Output Capacitance	$C_{OES}$		--	230	--	pF
Reverse Transfer Capacitance	$C_{RES}$		--	150	--	pF
Total Gate Charge	$Q_g$	$V_{CC} = 400V, I_C = 80A$ $V_{GE} = 15V$	--	216	324	nC
Gate-Emitter Charge	$Q_{ge}$		--	30	46	nC
Gate-Collector Charge	$Q_{gc}$		--	106	159	nC
<b>SWITCHING</b> (Note 2)						
Turn-On Delay Time	$t_{d(on)}$	$V_{CC} = 400V, I_C = 40A$ $R_G = 5\Omega, V_{GE} = 15V$ Inductive Load, $T_{vj} = 25^{\circ}\text{C}$	--	36	--	ns
Rise Time	$t_r$		--	69	--	ns
Turn-Off Delay Time	$t_{d(off)}$		--	140	--	ns
Fall Time	$t_f$		--	21	--	ns
Turn-On Switching Loss	$E_{ON}$		--	1.28	--	mJ
Turn-Off Switching Loss	$E_{OFF}$		--	0.24	--	mJ
Total Switching Loss	$E_{TS}$		--	1.52	--	mJ
Turn-On Delay Time	$t_{d(on)}$	$V_{CC} = 400V, I_C = 80A$ $R_G = 5\Omega, V_{GE} = 15V$ Inductive Load, $T_{vj} = 25^{\circ}\text{C}$	--	57	--	ns
Rise Time	$t_r$		--	139	--	ns
Turn-Off Delay Time	$t_{d(off)}$		--	118	--	ns
Fall Time	$t_f$		--	65	--	ns
Turn-On Switching Loss	$E_{ON}$		--	3.05	4.58	mJ
Turn-Off Switching Loss	$E_{OFF}$		--	1.11	1.67	mJ
Total Switching Loss	$E_{TS}$		--	4.16	6.24	mJ

### Electrical Characteristics of the IGBT $T_{vj}=25^{\circ}\text{C}$ , unless otherwise noted

Parameter	Symbol	Test condition	Min.	Typ.	Max.	Unit
<b>SWITCHING</b> (Note 2)						
Turn-On Delay Time	$t_{d(on)}$	$V_{CC} = 400\text{V}, I_C = 40\text{A}$ $R_G = 5\Omega, V_{GE} = 15\text{V}$ Inductive Load, $T_{vj} = 175^{\circ}\text{C}$	--	41	--	ns
Rise Time	$t_r$		--	63	--	ns
Turn-Off Delay Time	$t_{d(off)}$		--	149	--	ns
Fall Time	$t_f$		--	21	--	ns
Turn-On Switching Loss	$E_{ON}$		--	1.91	--	mJ
Turn-Off Switching Loss	$E_{OFF}$		--	0.41	--	mJ
Total Switching Loss	$E_{TS}$	--	2.32	--	mJ	
Turn-On Delay Time	$t_{d(on)}$	$V_{CC} = 400\text{V}, I_C = 80\text{A}$ $R_G = 5\Omega, V_{GE} = 15\text{V}$ Inductive Load, $T_{vj} = 175^{\circ}\text{C}$	--	47	--	ns
Rise Time	$t_r$		--	136	--	ns
Turn-Off Delay Time	$t_{d(off)}$		--	126	--	ns
Fall Time	$t_f$		--	62	--	ns
Turn-On Switching Loss	$E_{ON}$		--	4.94	7.41	mJ
Turn-Off Switching Loss	$E_{OFF}$		--	1.26	1.89	mJ
Total Switching Loss	$E_{TS}$	--	6.20	9.30	mJ	

Notes :

(2) Not subject to production test – verified by design/characterization

### Electrical Characteristics of the DIODE $T_{vj}=25^{\circ}\text{C}$ , unless otherwise noted

Parameter	Symbol	Test condition	Min.	Typ.	Max.	Unit
Diode Forward Voltage	$V_{FM}$	$I_F = 40\text{A}, T_{vj} = 25^{\circ}\text{C}$	--	2.30	--	V
		$I_F = 40\text{A}, T_{vj} = 125^{\circ}\text{C}$	--	2.09	--	V
		$I_F = 40\text{A}, T_{vj} = 175^{\circ}\text{C}$	--	1.93	--	V
		$I_F = 80\text{A}, T_{vj} = 25^{\circ}\text{C}$	--	2.93	--	V
		$I_F = 80\text{A}, T_{vj} = 125^{\circ}\text{C}$	--	2.88	--	V
		$I_F = 80\text{A}, T_{vj} = 175^{\circ}\text{C}$	--	2.78	--	V
Reverse Recovery Time	$t_{rr}$	$I_F = 40\text{A},$ $di/dt = 200\text{A}/\mu\text{s},$ $T_{vj} = 25^{\circ}\text{C}$	--	62	--	ns
Reverse Recovery Current	$I_{rr}$		--	5.2	--	A
Reverse Recovery Charge	$Q_{rr}$		--	196	--	nC
Reverse Recovery Time	$t_{rr}$	$I_F = 40\text{A},$ $di/dt = 200\text{A}/\mu\text{s},$ $T_{vj} = 175^{\circ}\text{C}$	--	168	--	ns
Reverse Recovery Current	$I_{rr}$		--	9.9	--	A
Reverse Recovery Charge	$Q_{rr}$		--	1102	--	nC
Reverse Recovery Time	$t_{rr}$	$I_F = 80\text{A},$ $di/dt = 200\text{A}/\mu\text{s},$ $T_{vj} = 25^{\circ}\text{C}$	--	74	--	ns
Reverse Recovery Current	$I_{rr}$		--	6.0	--	A
Reverse Recovery Charge	$Q_{rr}$		--	280	--	nC
Reverse Recovery Time	$t_{rr}$	$I_F = 80\text{A},$ $di/dt = 200\text{A}/\mu\text{s},$ $T_{vj} = 175^{\circ}\text{C}$	--	171	--	ns
Reverse Recovery Current	$I_{rr}$		--	11.0	--	A
Reverse Recovery Charge	$Q_{rr}$		--	1218	--	nC

### IGBT Characteristics

Fig. 1 IGBT Output Characteristics

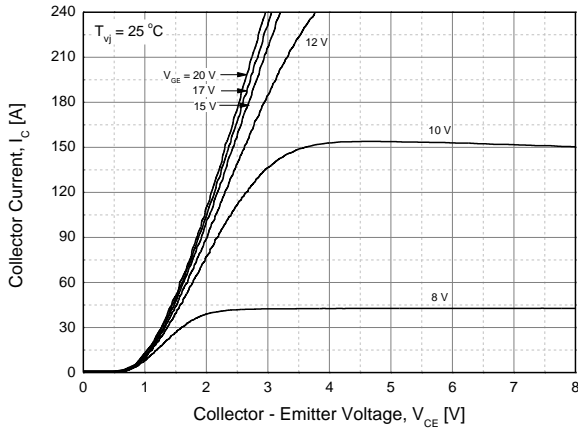

Fig. 2 IGBT Output Characteristics

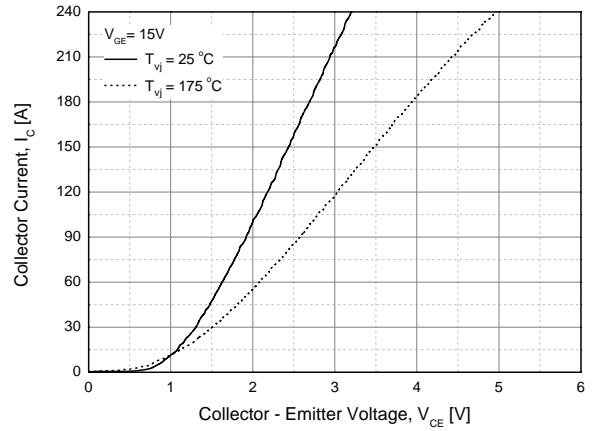

Fig. 3 IGBT Saturation Voltage vs. Junction Temperature

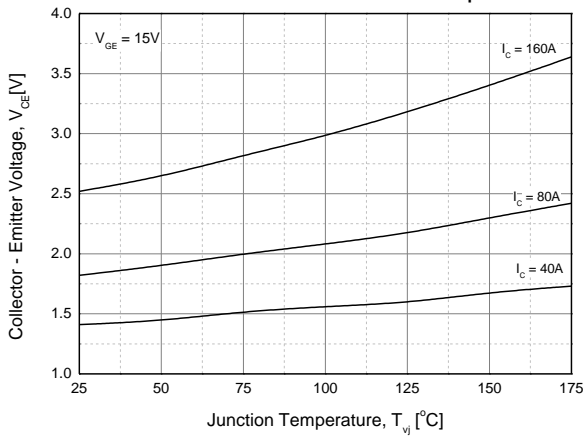

Fig. 4 IGBT Saturation Voltage vs. Gate Bias

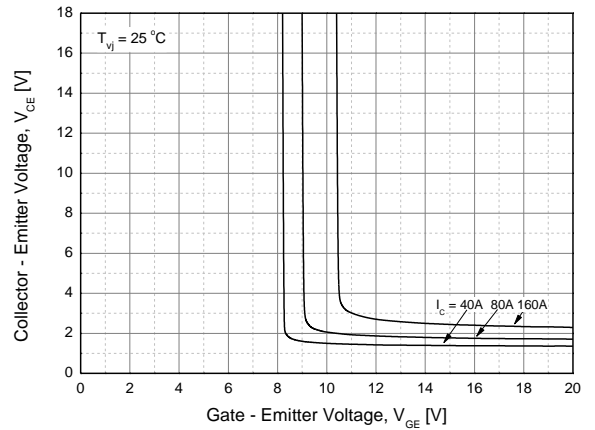

Fig. 5 IGBT Saturation Voltage vs. Gate Bias

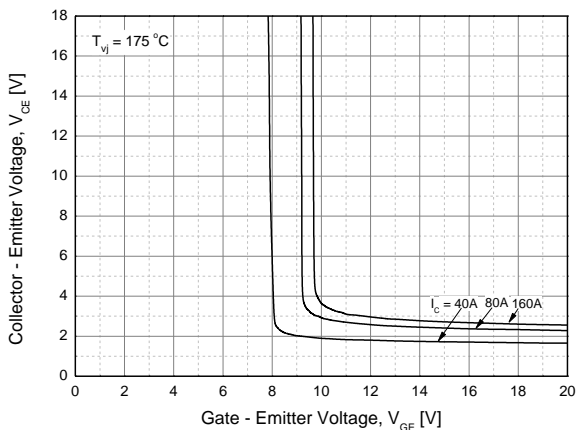
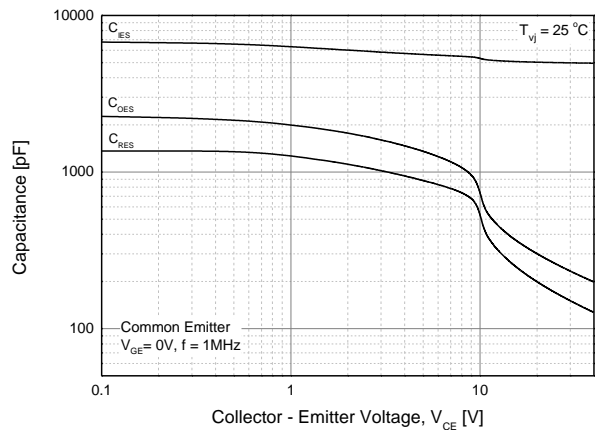

Fig. 6 IGBT Capacitance Characteristics



### IGBT Characteristics

Fig. 7 Turn-on Time vs. Gate Resistor

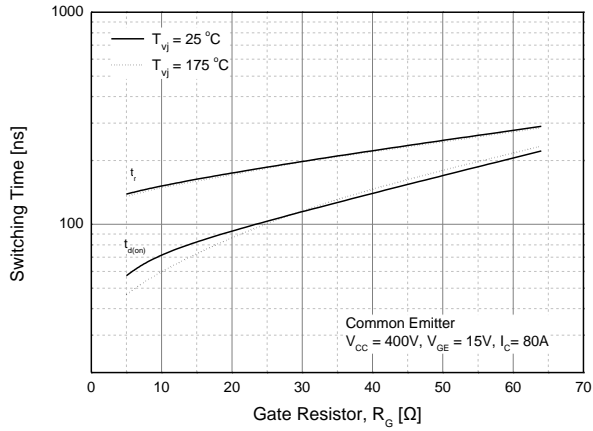

Fig. 8 Turn-off Time vs. Gate Resistor

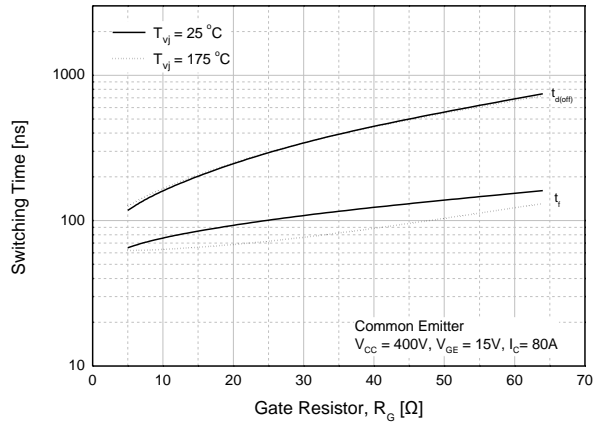

Fig. 9 Switching Loss vs. Gate Resistor

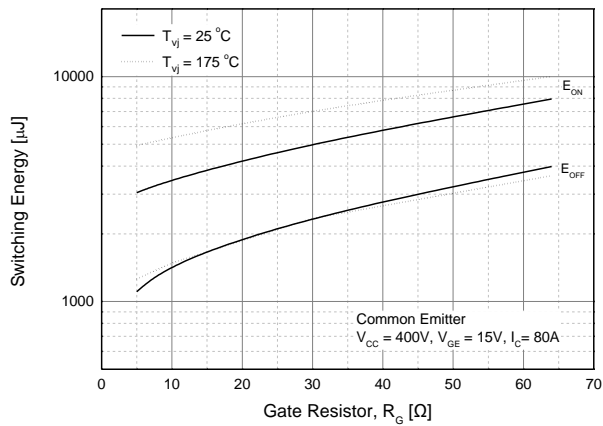

Fig. 10 Turn-on Time vs. Collector Current

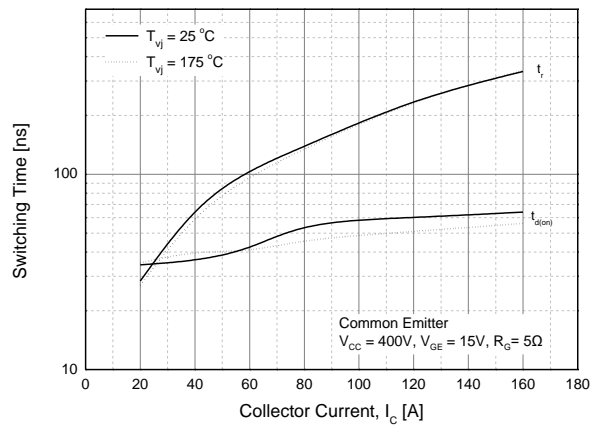

Fig. 11 Turn-off Time vs. Collector Current

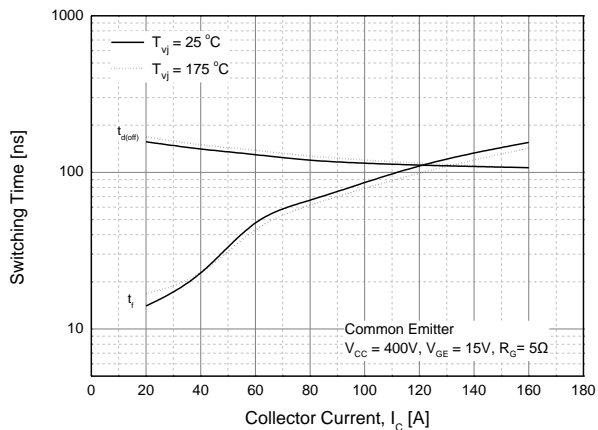
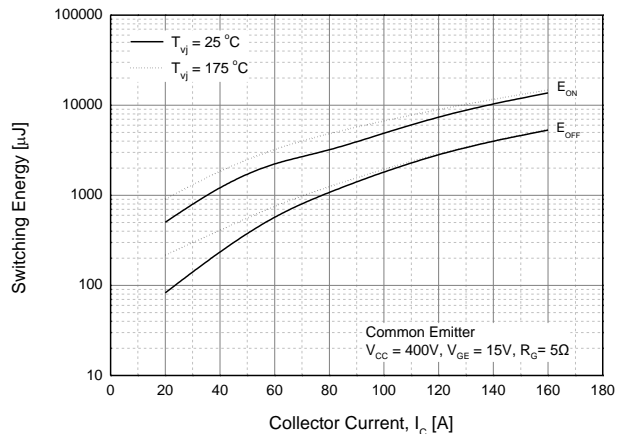

Fig. 12 Switching Loss vs. Collector Current



### IGBT Characteristics

Fig. 13 Gate Charge Characteristics

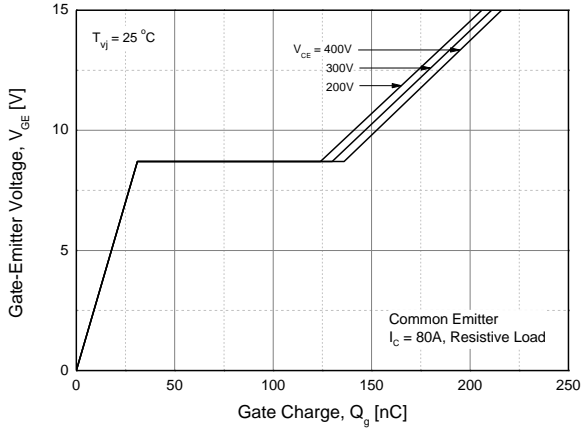

Fig. 14 SOA

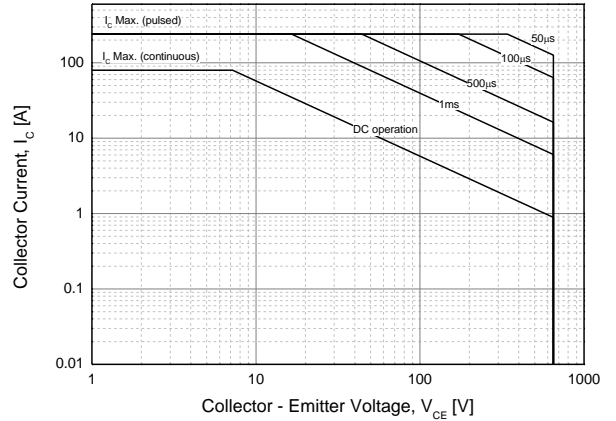

Fig. 15 RBSOA

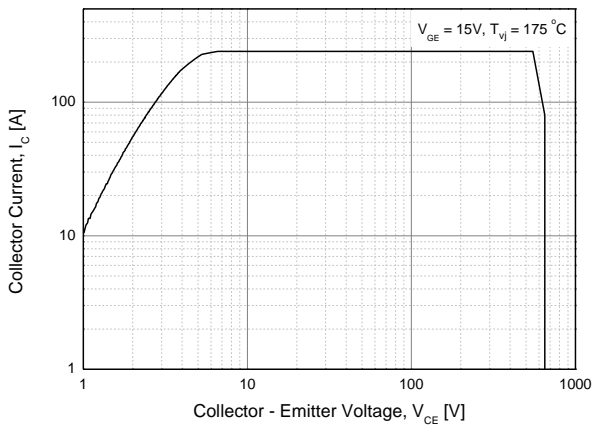

Fig. 16 Transient Thermal Impedance of IGBT

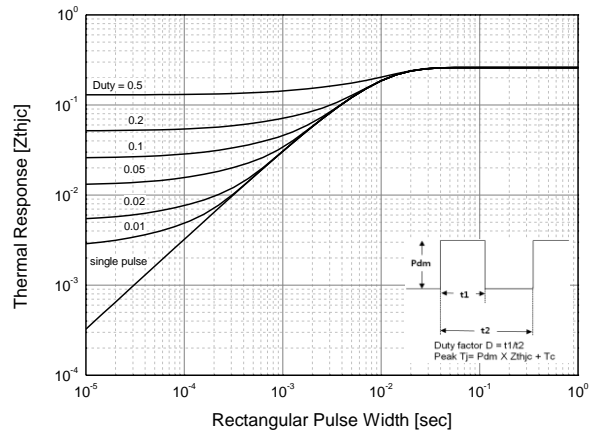
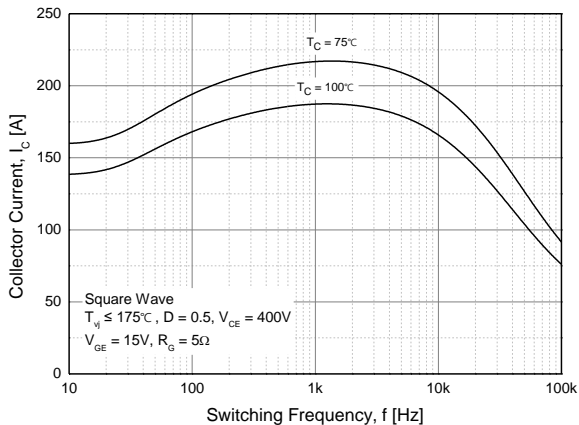

Fig. 17 Load Current vs. Frequency



## DIODE Characteristics

Fig. 18 Diode Conduction Characteristics

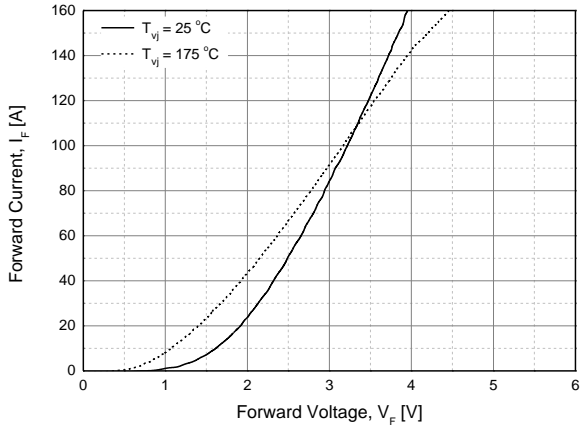

Fig. 19 Reverse Recovery Current vs. Forward Current

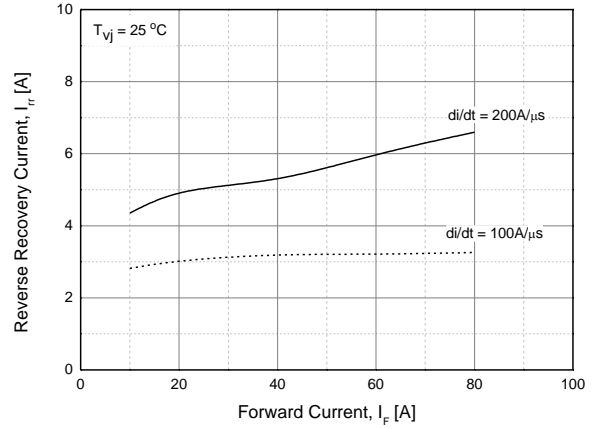

Fig. 20 Reverse Recovery Charge vs. Forward Current

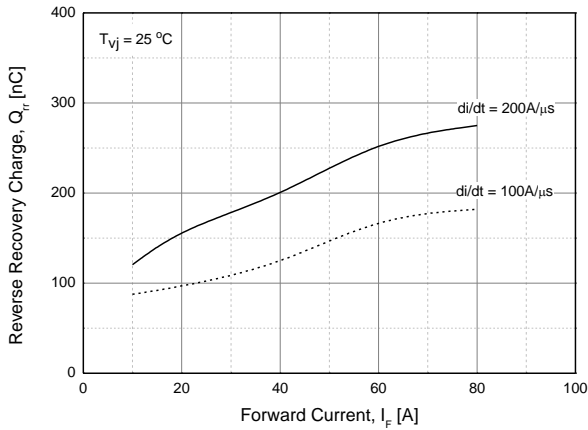
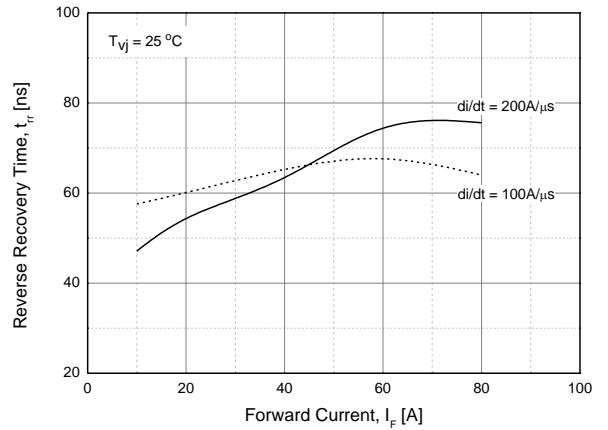
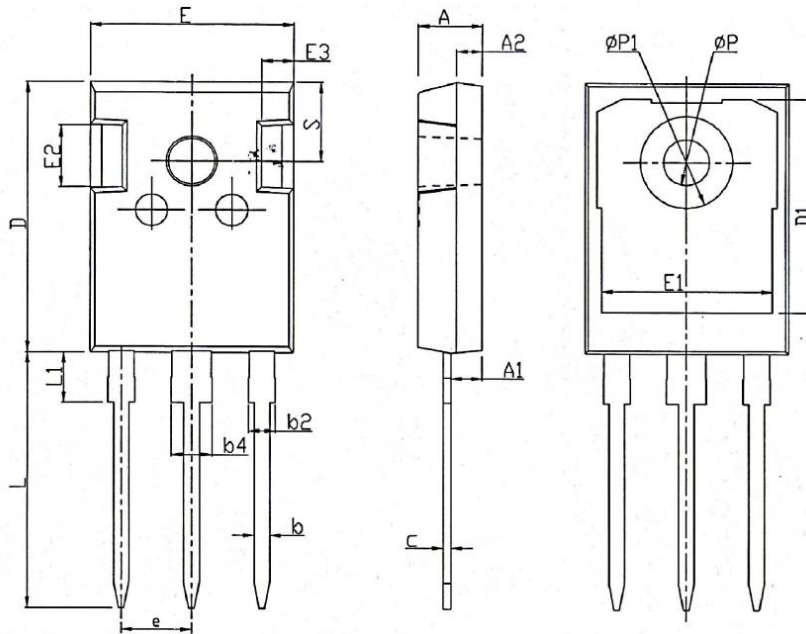

Fig. 21 Reverse Recovery Time vs. Forward Current





**TO-247 MECHANICAL DATA**



SYMBOL	mm		
	MIN	NOM	MAX
A	4.80	5.00	5.20
A1	2.21	2.41	2.59
A2	1.85	2.00	2.15
b	1.11	1.21	1.36
b2	1.91	2.01	2.21
b4	2.91	3.01	3.21
c	0.51	0.61	0.75
D	20.80	21.00	21.30
D1	16.25	16.55	16.85
E	15.50	15.80	16.10
E1	13.00	13.30	13.60
E2	4.80	5.00	5.20
E3	2.30	2.50	2.70
e	5.44BSC		
L	19.62	19.92	20.22
L1	-	-	4.30
ΦP	3.40	3.60	3.80
ΦP1	-	-	7.30
S	6.15BSC		

**Disclaimer**

TRinno technology reserves the right to make changes without notice to products herein to improve reliability, performance, or design. The information given in this document is believed to be accurate and reliable. However, it shall in no event be regarded as a guarantee of conditions and characteristics. With respect to any information regarding the application of the device, TRinno technology hereby disclaims any and all warranties and liabilities of any kind, including without limitation, warranties of non-infringement of patent rights of any third party.